

# BLX

1

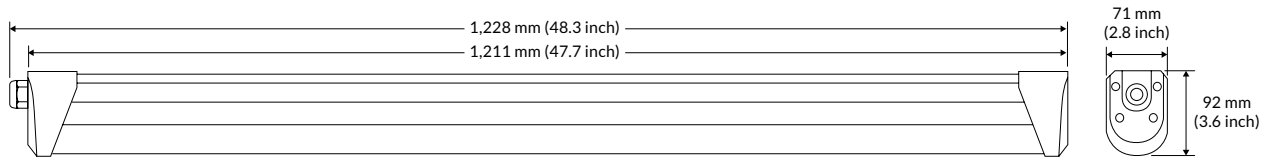

2

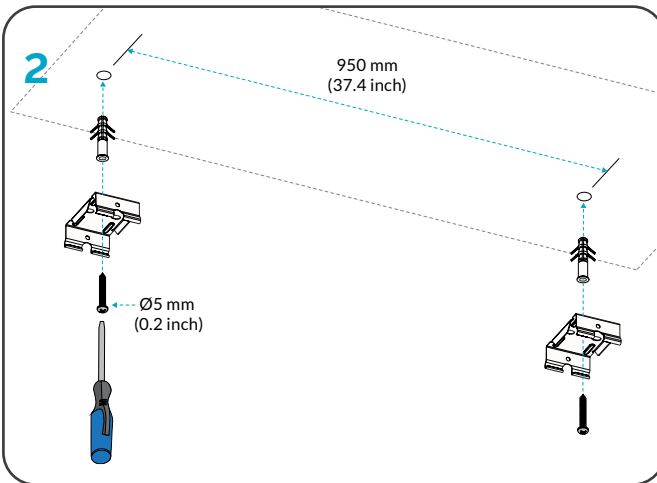

3

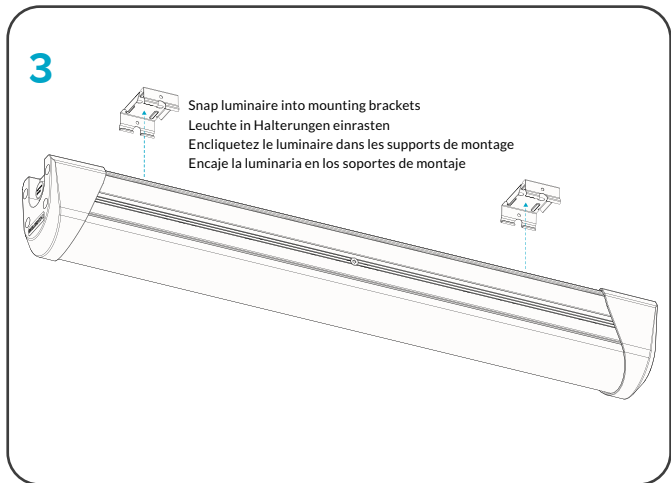

4

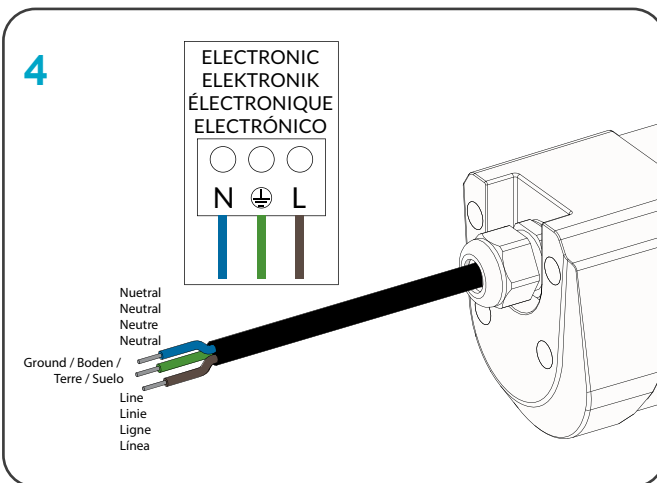

5

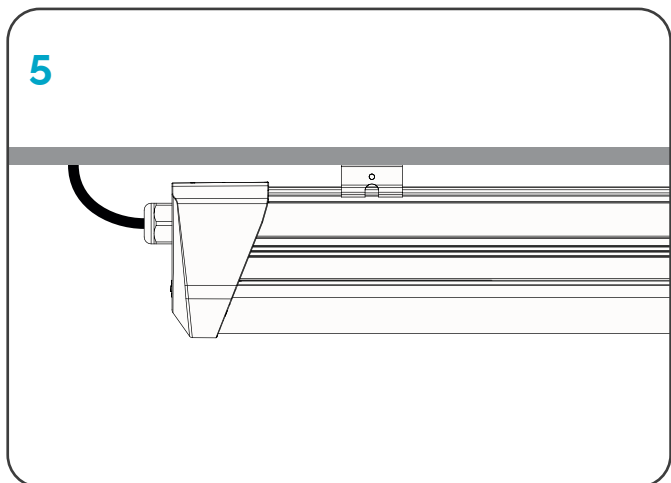





















## PRODUCT SAFETY

When using electrical equipment, basic safety precautions should always be followed, including the following:



### READ THESE INSTRUCTIONS BEFORE USING THIS PRODUCT.

-  This product must be installed in accordance with the applicable installation codes by a person familiar with the construction and operation of the product and the hazards involved.
-  Installation of luminaire must be in accordance with national and local building and electrical codes.
-  Disconnect or turn off power before installing or servicing luminaire.
-  All electrical wiring to be completed by a qualified licensed electrician in accordance with local and National/Canadian Electrical Code.
-  Ensure supply voltage corresponds with the correct ballast/driver voltage.
-  Avoid exposing wiring to metal edges and sharp objects.
-  Ensure that the luminaire is properly grounded to prevent electric hazards.
-  Carefully read and follow all warnings and instructions before installing or servicing the luminaire.
-  Instructions do not cover all details and all possible product configurations.
-  Ensure LED luminaire has the correct polarity before installation.
-  Keep flammable and combustible materials away from the light source and/or lens.
-  Use correctly rated supply conductors as indicated by product labeling.
-  Wear safety glasses and gloves when handling the luminaire to avoid physical injury.
-  Avoid direct eye contact with light source.
-  Always support the weight of the luminaire.
-  Do not restrict luminaire ventilation.
-  Allow luminaire to cool before handling luminaire.
-  Ensure LED luminaire is not covered with material that will prevent convection or conduction cooling.
-  Do not exceed luminaire's maximum ambient temperature.
-  These products have maximum rated output voltage that exceeds the voltage limits that cannot be accessible based on voltage restrictions for Class 2 circuits in Canadian Electrical Code. This output complies with the definition of Class 2 per Canadian Electrical Code. This product complies with this requirement since the installation instruction requires installation in restricted access area.
-  Do not mount the luminaire to ceiling if convenience outlet option is provided.
-  Do not use the luminaire housing as junction box cover unless the housing width is wider than the junction box.



### SAVE THESE INSTRUCTIONS.

## GETTING STARTED

Instructions do not cover all details and all possible product configurations.

### Verify Luminaire

- 1 Review the BLX dimensional drawing on page 1 (**Illustration 1**).
- 2 Verify luminaire length:
  - BLX-D1 – 1.2 m (4 ft)

### Installing the BLX

- 1 Install screw anchors into the ceiling, centering the anchors 950 mm (37.4 inch) apart. Using a Ø5 mm (0.2 inch) screw secure mounting brackets to the ceiling (**Illustration 2**).
- 2 Secure the BLX by snapping the luminaire into both mounting brackets. Once in place you will hear a click (**Illustration 3**).























### Make Electrical Connections

- 1 Connect ground wire from electrical supply to the ground wire on the luminaire or to the ground screw located on the luminaire. Then connect electrical supply wires (brown and blue) to the corresponding wires from the luminaire, according to NEC or local codes (**Illustration 4**).
  - Brown (Line)
  - Blue (Neutral)
  - Ground
- 2 3 m (10 ft) leader cable is now connected (**Illustration 5**).

## PRODUKTSICHERHEIT

Bei der Verwendung elektrischer Geräte sollten immer die grundlegenden Sicherheitsvorkehrungen beachtet werden, einschließlich der folgenden:

### **LESEN SIE DIESE ANWEISUNGEN VOR DEM VERWENDEN DES PRODUKTS.**

-  Dieses Produkt muss gemäß den geltenden Installationsvorschriften von einer Person installiert werden, die mit der Konstruktion und Bedienung des Produkts und den damit verbundenen Gefahren vertraut ist.
-  Die Installation der Leuchte muss in in Übereinstimmung mit den nationalen und lokalen Bau- und Elektrovorschriften.
-  Trennen oder schalten Sie die Stromversorgung aus, bevor Sie die Leuchte installieren oder warten.
-  Die gesamte elektrische Verkabelung muss von einem qualifizierten, lizenzierten Elektriker in Übereinstimmung mit den lokalen und nationalen/kanadischen Elektrovorschriften durchgeführt werden.
-  Stellen Sie sicher, dass die Versorgungsspannung der korrekten Vorschalt-/Treiberspannung entspricht.
-  Vermeiden Sie es, die Kabel Metallkanten und Scharfe Objekte.
-  Stellen Sie sicher, dass die Leuchte ordnungsgemäß geerdet ist, um elektrische Gefahren zu vermeiden.
-  Lesen und befolgen Sie alle Warnungen und Anweisungen vor der Installation oder Wartung sorgfältig die Leuchte.
-  Anweisungen decken nicht alle Details und alle möglichen Produktkonfigurationen ab.
-  Stellen Sie vor der Installation sicher, dass die LED-Leuchte die richtige Polarität hat.
-  Halten Sie brennbare und brennbare Materialien von der Lichtquelle und/oder Linse fern.
-  Verwenden Sie entsprechend der Produktkennzeichnung korrekt bemessene Versorgungsleiter.
-  Tragen Sie beim Umgang mit der Leuchte eine Schutzbrille und Handschuhe, um Verletzungen zu vermeiden.
-  Vermeiden Sie direkten Augenkontakt mit der Lichtquelle.
-  Stützen Sie immer das Gewicht der Leuchte.
-  Leuchtenbelüftung nicht einschränken.
-  Lassen Sie die Leuchte abkühlen, bevor Sie mit der Leuchte umgehen.
-  Stellen Sie sicher, dass die LED-Leuchte nicht mit bedeckt ist Material, das Konvektion oder Konduktionskühlung verhindert.
-  Überschreiten Sie nicht das Maximum der Leuchte Umgebungstemperatur.
-  Diese Produkte haben eine maximale Nennausgangsspannung, die die Spannungsgrenzen überschreitet, die aufgrund der Spannungsbeschränkungen für Stromkreise der Klasse 2 im Canadian Electrical Code nicht zugänglich sind. Dieser Ausgang entspricht der Definition der Klasse 2 gemäß Canadian Electrical Code. Dieses Produkt erfüllt diese Anforderung, da die Installationsanleitung die Installation in einem Bereich mit eingeschränktem Zugang erfordert.
-  Montieren Sie die Leuchte nicht an der Decke, wenn eine Komfortsteckdose vorhanden ist.
-  Verwenden Sie das Leuchtengehäuse nicht als Anschlusskastenabdeckung, es sei denn, die Gehäusebreite ist breiter als die Anschlussdose.

### **CONSERVEZ CES INSTRUCTIONS.**

## COMMENCER

Anweisungen decken nicht alle Details und alle möglichen Produktkonfigurationen ab.

### Leuchte überprüfen

- 1 Sehen Sie sich die BLX-Maßzeichnung auf Seite 1 an (**Abbildung 1**).
- 2 Leuchtenlänge Prüfen:
  - BLX-D1 – 1.2 m (4 ft)

### Installation des BLX

- 1 Montieren Sie die Schraubanker in die Decke und zentrieren Sie die Anker mit einem Abstand von 950 950 mm (37.4 Zoll). Mit einem Ø5 mm (0.2 Zoll) schrauben Sie die Montagehalterungen an der Decke fest (**Abbildung 2**).
- 2 Sichern Sie den BLX, indem Sie die Leuchte in beide Halterungen einrasten. Nach dem Einsetzen hörst du ein Klicken (**Abbildung 3**).























### Raccordements Électriques

- 1 Schließen Sie das Erdungskabel der Stromversorgung an das Erdungskabel der Leuchte oder an die Erdungsschraube an der Leuchte an. Verbinden Sie dann die elektrischen Versorgungskabel (braun und blau) mit den entsprechenden Kabeln der Leuchte gemäß NEC oder lokalen Vorschriften (**Abbildung 4**).
  - Braun (Linie)
  - Blau (Neutral)
  - Boden
- 2 3 m (10 ft) langes Führungskabel ist jetzt angeschlossen (**Abbildung 5**).

## SÉCURITÉ DU PRODUIT

Lors de l'utilisation d'équipements électriques, des précautions de sécurité de base doivent toujours être suivies, notamment les suivantes:

### **LISEZ CES INSTRUCTIONS AVANT D'UTILISER LE PRODUIT.**

-  Ce produit doit être installé conformément aux codes d'installation applicables par une personne familière avec la construction et le fonctionnement du produit et les risques impliqués.
-  L'installation du luminaire doit être en conformité aux codes nationaux et locaux du bâtiment et de l'électricité.
-  Débranchez ou coupez l'alimentation avant d'installer ou d'entretenir le luminaire.
-  Tout le câblage électrique doit être effectué par un électricien qualifié et agréé conformément au code électrique local et national/canadien.
-  Assurez-vous que la tension d'alimentation correspond à la tension correcte du ballast/pilote.
-  Évitez d'exposer le câblage à des bords métalliques et objets tranchants.
-  Assurez-vous que le luminaire est correctement mis à la terre pour éviter les risques électriques.
-  Lisez attentivement et suivez tous les avertissements et instructions avant l'installation ou l'entretien le luminaire.
-  Les instructions ne couvrent pas tous les détails et toutes les configurations de produits possibles.
-  Assurez-vous que le luminaire LED a la bonne polarité avant l'installation.
-  Tenir les matériaux inflammables et combustibles éloignés de la source lumineuse et/ou de la lentille.
-  Utilisez des conducteurs d'alimentation correctement calibrés, comme indiqué sur l'étiquette du produit.
-  Portez des lunettes de sécurité et des gants lors de la manipulation du luminaire pour éviter les blessures physiques.
-  Éviter le contact visuel direct avec la source lumineuse.
-  Supportez toujours le poids du luminaire.
-  Ne pas restreindre la ventilation du luminaire.
-  Laisser le luminaire refroidir avant de manipuler le luminaire.
-  Assurez-vous que le luminaire LED n'est pas recouvert de matériau qui empêchera le refroidissement par convection ou conduction.
-  Ne pas dépasser le maximum du luminaire température ambiante.
-  Ces produits ont une tension de sortie nominale maximale qui dépasse les limites de tension qui ne peuvent pas être accessibles en fonction des restrictions de tension pour les circuits de classe 2 dans le Code canadien de l'électricité. Cette sortie est conforme à la définition de la classe 2 selon le Code canadien de l'électricité. Ce produit est conforme à cette exigence puisque les instructions d'installation nécessitent une installation dans une zone d'accès restreint.
-  Ne montez pas le luminaire au plafond si l'option de sortie pratique est fournie.
-  N'utilisez pas le boîtier du luminaire comme couvercle de boîte de jonction à moins que la largeur du boîtier ne soit plus large que la boîte de jonction.

### **ANLEITUNG AUFBEWAHREN.**

## ANFANGEN

Les instructions ne couvrent pas tous les détails et toutes les configurations de produits possibles.

### Vérifier le Luminaire

- 1 Consultez le dessin coté BLX à la page 1 (**Figure 1**).
- 2 Vérifiez la longueur du luminaire:
  - BLX-D1 – 1.2 m (4 ft)

### Installation du BLX

- 1 Installez les chevilles à vis dans le plafond, en centrant les chevilles à 950 mm (37.4 pouces) l'une de l'autre. Utilisez un Ø5 mm (0.2 pouces) visser les supports de montage au plafond (**Figure 2**).
- 2 Fixez le BLX en enclenchant le luminaire dans les deux supports de montage. Une fois en place, vous entendrez un clic (**Figure 3**).

### Elektrische Verbindungen Herstellen























- 1 Connectez le fil de terre de l'alimentation électrique au fil de terre du luminaire ou à la vis de terre située sur le luminaire. Connectez ensuite les fils d'alimentation électrique (marron et bleu) aux fils correspondants du luminaire, conformément au NEC ou aux codes locaux (**Figure 4**).
  - Marron (Ligne)
  - Bleu (Neutre)
  - Terre
- 2 Le câble leader de 3 m (10 ft) est maintenant connecté (**Figure 5**).

## SEGURIDAD DEL PRODUCTO

Al utilizar equipos eléctricos, siempre se deben seguir las precauciones básicas de seguridad, incluidas las siguientes:



### LEA ESTAS INSTRUCCIONES ANTES DE USAR EL PRODUCTO.

-  Este producto debe ser instalado de acuerdo con los códigos de instalación aplicables por una persona familiarizada con la construcción y operación del producto y los peligros involucrados.
-  La instalación de la luminaria debe estar en de acuerdo con los códigos eléctricos y de construcción nacionales y locales.
-  Desconecte o apague la energía antes de instalar o reparar la luminaria.
-  Todo el cableado eléctrico debe ser completado por un electricista autorizado y calificado de acuerdo con el Código Eléctrico local y nacional / canadiense.
-  Asegúrese de que el voltaje de suministro corresponda con el voltaje correcto del balasto / controlador.
-  Evite exponer el cableado a bordes metálicos y objetos afilados.
-  Asegúrese de que la luminaria esté debidamente conectada a tierra para evitar peligros eléctricos.
-  Lea atentamente y siga todas las advertencias e instrucciones antes de instalar o reparar la luminaria.
-  Las instrucciones no cubren todos los detalles ni todas las configuraciones posibles del producto.
-  Asegúrese de que la luminaria LED tenga la polaridad correcta antes de la instalación.
-  Mantenga los materiales inflamables y combustibles alejados de la fuente de luz y / o la lente.
-  Utilice conductores de alimentación con la clasificación correcta según lo indicado en la etiqueta del producto.
-  Utilice gafas de seguridad y guantes al manipular la luminaria para evitar lesiones físicas.
-  Evite el contacto visual directo con la fuente de luz.
-  Soporta siempre el peso de la luminaria.
-  No restrinja la ventilación de la luminaria.
-  Deje que la luminaria se enfríe antes de manipularla.
-  Asegúrese de que la luminaria LED no esté cubierta con material que evitará el enfriamiento por convección o conducción.
-  No exceda el máximo de la luminaria temperatura ambiente.
-  Estos productos tienen un voltaje de salida nominal máximo que excede los límites de voltaje a los que no se puede acceder según las restricciones de voltaje para circuitos de Clase 2 en el Código Eléctrico Canadiense. Esta salida cumple con la definición de Clase 2 según el Código Eléctrico Canadiense. Este producto cumple con este requisito ya que las instrucciones de instalación requieren la instalación en un área de acceso restringido.
-  No monte la luminaria en el techo si se proporciona la opción de salida de conveniencia.
-  No utilice la carcasa de la luminaria como tapa de la caja de conexiones a menos que el ancho de la carcasa sea más ancho que la caja de conexiones.



### GUARDA ESTAS INSTRUCCIONES.



## EMPEZANDO

Las instrucciones no cubren todos los detalles ni todas las configuraciones posibles del producto.

### Verificar luminaria

- 1 Revise el dibujo dimensional de BLX en la página 1 (**Ilustración 1**).
- 2 Verifique la longitud de la luminaria:
  - BLX-D1 — 1.2 m (4 ft)

### Instalación del BLX

- 1 Instale anclajes de tornillos en el techo, centrando los anclajes a 950 mm (37.4 pulgadas) de distancia. Utilizando un Ø5 mm (0.2 pulgadas) atornille los soportes de montaje al techo (**Ilustración 2**).
- 2 Asegure el BLX encajando la luminaria en ambos soportes de montaje. Una vez en su lugar, escuchará un clic (**Ilustración 3**).

### Realizar Conexiones Eléctricas

- 1 Conecte el cable de tierra del suministro eléctrico al cable de tierra de la luminaria o al tornillo de tierra ubicado en la luminaria. Luego, conecte los cables de suministro eléctrico (marrón y azul) a los cables correspondientes de la luminaria, de acuerdo con NEC o códigos locales (**Ilustración 4**).
  - Marrón (Línea)
  - Azul (Neutral)
  - Suelo
- 2 El cable guía de 3 m (10 pies) ahora está conectado (**Ilustración 5**).

Copyright © 2021 Digital Lumens, Incorporated. All rights reserved. Digital Lumens, the Digital Lumens logo, We Generate Facility Wellness, SiteWorx, LightRules, Lightelligence, Encelium, the Encelium logo, Polaris, GreenBus and any other trademark, service mark, or tradename (collectively "the Marks") are either trademarks or registered trademarks of Digital Lumens, Inc. in the United States and/or other countries, or remain the property of their respective owners that have granted Digital Lumens, Inc. the right and license to use such Marks and/or are used herein as nominative fair use. Due to continuous improvements and innovations, specifications may change without notice.

**PUB-001008-00 Rev A 06-21**



[www.digitallumens.com](http://www.digitallumens.com)